

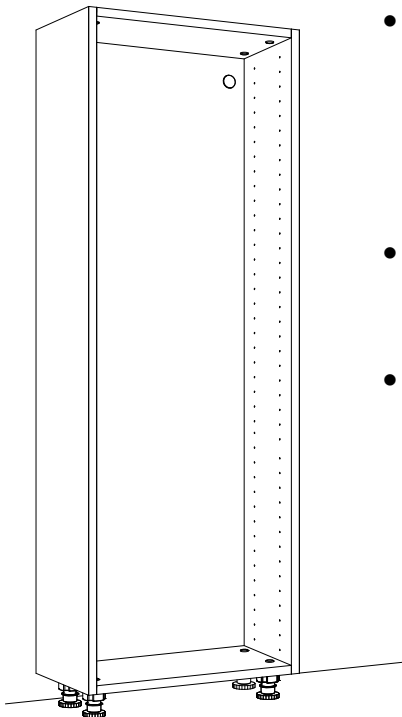

PRESENTATION GENERALE

- Panneaux mélaminés 19mm
- Joes filantes
3 chants plaqués
- Tablettes haute et basse
Tourillons + Excentrique
- Fond 10mm en rainure 4 cotés
Vide technique de 16mm
- Equerre de fixation murale
avec son cache
- Vis relieuse
pour assemblage de caisson
- Pied vérin H53 (+ 17 mm de réglages)
Plinthes à commander en élément de
 finition



- 4 hauteurs disponibles :
→ **733** mm
→ **1 553** mm
→ **2 103** mm
→ **2 453** mm
- Largeur sur mesure :
→ **350** mm à **950** mm
- Profondeur sur mesure :
→ **500** mm à **550** mm

EN OPTION:

Bandes led encastrés sur
joue

EQUIPEMENTS

Tablettes

En retrait de 5 mm par
rapport au rangement

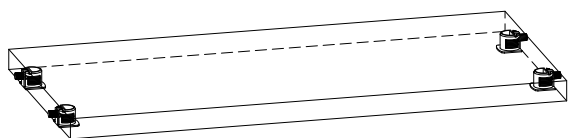

Tablette fixe

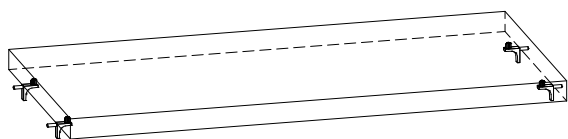

Tablette semi-mobile

Porte sur charnières

En applique

Charnières invisibles coudée 0

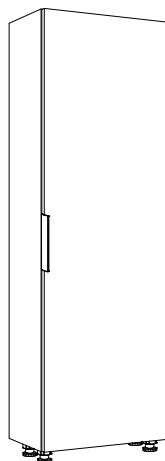

Largeur ≤ 650 mm
1 porte

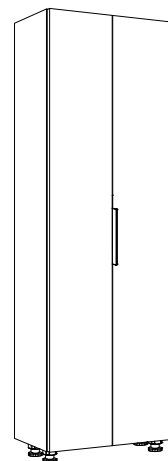

Largeur > 650 mm
2 portes

* 1 poignée pour 2
portes

Tirant à choisir à la commande
1 poignée EDGE 200 mm
à positionner par le client

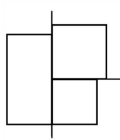

ad

L'essentiel FICHE TECHNIQUE

NOVEMBRE 2024

GAMME CONCEPT - DRESSING

EQUIPEMENTS SUITE

Blocs tiroirs

Bloc tiroirs pour aménagement sans porte sur charnières

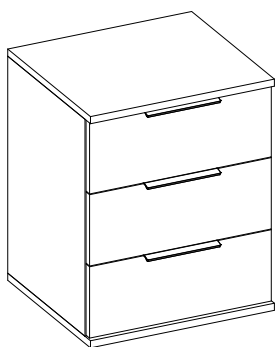

- Tiroirs en applique
- Posé sur kit fixe
- Retrait de 5 mm par rapport au rangement
- Poignée Edge 200 mm
- Coulisses sortie totale

Bloc tiroirs pour aménagement avec portes sur charnières

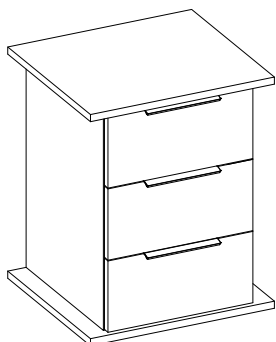

- Tiroirs en applique
- Posé sur kit fixe
- Vide technique de 50 mm du côté des charnières
Fourni avec un fileur à poser par le client
- Retrait de 30 mm par rapport au rangement
- Poignée Edge 200 mm
- Coulisses sortie totale

Penderie

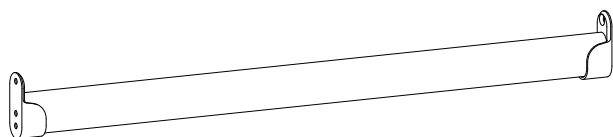

Tringle penderie ovale
aluminium finition Argent
Avec joint antibruit

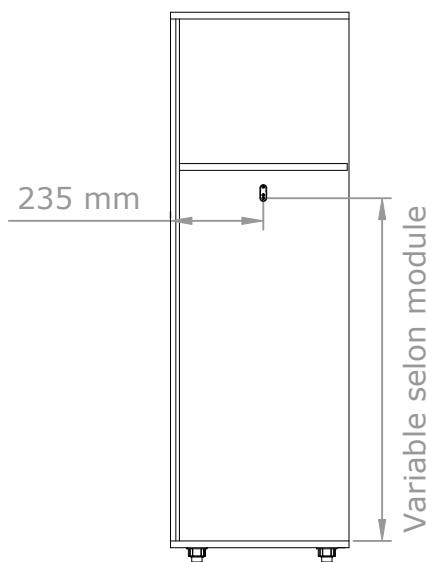
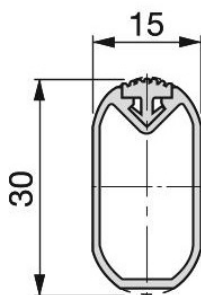

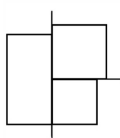

ad

L'essentiel FICHE TECHNIQUE

NOVEMBRE 2024

GAMME CONCEPT - DRESSING

MODULES

Hauteur 733 mm

D7-M1

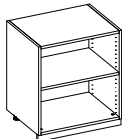

1 tablette semi-mobile

D7-M2

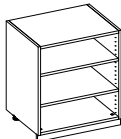

2 tablettes semi-mobiles

D7-M3

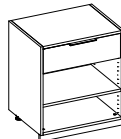

1 tablette semi-mobile
1 tiroir seul

D7-M4



1 tablette fixe (excentrique)
2 tiroirs seuls
Pas de système 32

Hauteur 1 553 mm

D15-M1

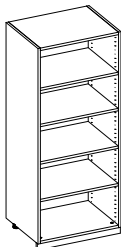

1 tablette fixe
3 tablettes semi-mobiles

D15-M2

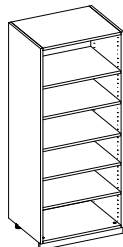

1 tablette fixe
4 tablettes semi-mobiles

D15-M3

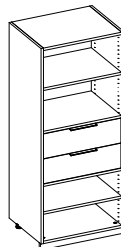

1 tablette fixe
1 tablette semi-mobile
1 bloc 2 tiroirs

D15-M4

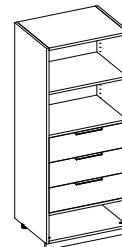

1 tablette fixe
1 bloc 3 tiroirs

D15-M5

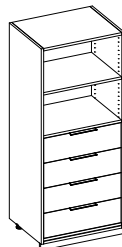

1 tablette fixe
1 bloc 4 tiroirs

D15-M6

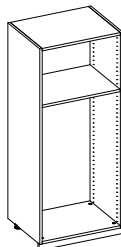

1 tablette fixe
1 penderie

D15-M7

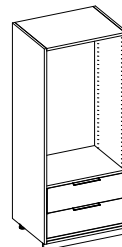

1 bloc 2 tiroirs
1 penderie

Hauteur 2 103 mm

D21-M1

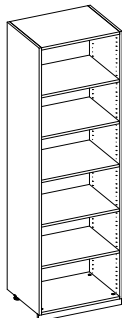

1 tablette fixe
4 tablettes semi-mobiles

D21-M2

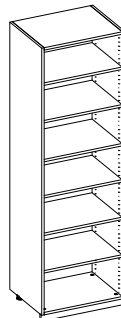

1 tablette fixe
5 tablettes semi-mobiles

D21-M3

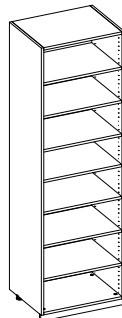

1 tablette fixe
6 tablettes semi-mobiles

D21-M4

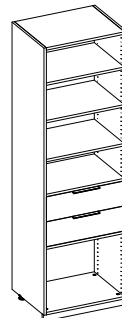

1 tablette fixe
2 tablettes semi-mobiles
1 bloc 2 tiroirs

D21-M5

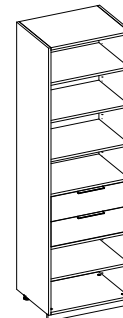

1 tablette fixe
3 tablettes semi-mobiles
1 bloc 2 tiroirs

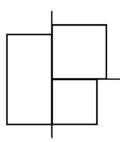

ad

L'essentiel FICHE TECHNIQUE

NOVEMBRE 2024

GAMME CONCEPT - DRESSING

MODULES SUITE

Hauteur 2 103 mm

D12-M6

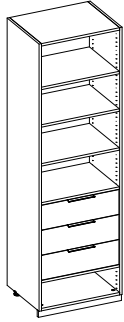

1 tablette fixe
2 tablettes semi-mobiles
1 bloc 3 tiroirs

D21-M7

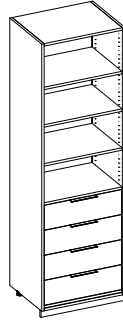

1 tablette fixe
2 tablettes semi-mobiles
1 bloc 4 tiroirs

D21-M8

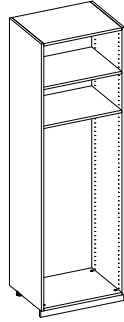

1 tablette fixe
1 tablette semi-mobile
1 penderie

D21-M9

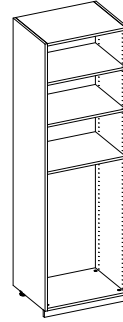

1 tablette fixe
2 tablettes semi-mobiles
1 penderie

D21-M10

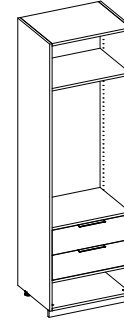

1 tablette fixe
1 bloc 2 tiroirs
1 penderie

D21-M11

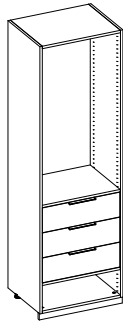

1 bloc 3 tiroirs
1 penderie

D21-M12

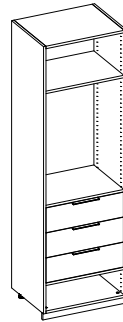

1 tablette fixe
1 bloc 3 tiroirs
1 penderie

D21-M13

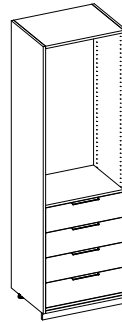

1 bloc 4 tiroirs
1 penderie

D21-M14

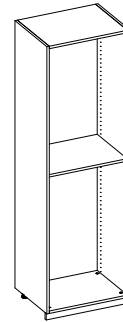

1 tablette fixe
2 penderies

Hauteur 2 453 mm

D24-M1

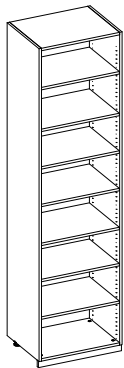

1 tablette fixe
6 tablettes semi-mobiles

D24-M2

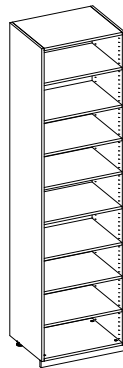

1 tablette fixe
7 tablettes semi-mobiles

D24-M3

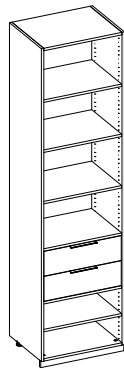

1 tablette fixe
3 tablettes semi-mobiles
1 bloc 2 tiroirs

D24-M4

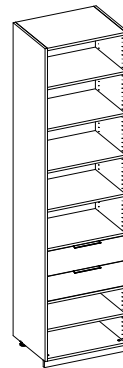

1 tablette fixe
4 tablettes semi-mobiles
1 bloc 2 tiroirs

D24-M5

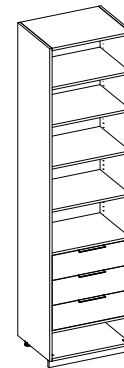

1 tablette fixe
3 tablettes semi-mobiles
1 bloc 3 tiroirs

MODULES SUITE

Hauteur 2 453 mm

D24-M6

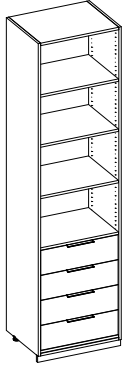

1 tablette fixe
2 tablettes semi-mobiles
1 bloc 4 tiroirs

D24-M7

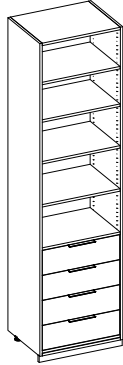

1 tablette fixe
3 tablettes semi-mobiles
1 bloc 4 tiroirs

D24-M8

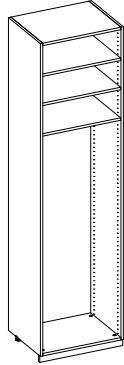

1 tablette fixe
2 tablettes semi-mobiles
1 penderie

D24-M9

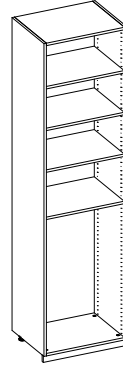

1 tablette fixe
3 tablettes semi-mobiles
1 penderie

D24-M10

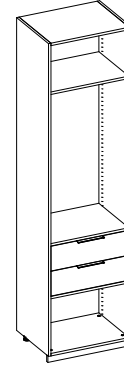

1 tablette fixe
1 bloc 2 tiroirs
1 penderie

D24-M11

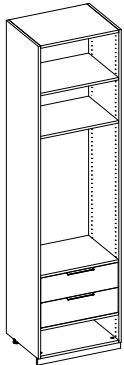

1 tablette fixe
1 tablette semi-mobile
1 bloc 2 tiroirs
1 penderie

D24-M12

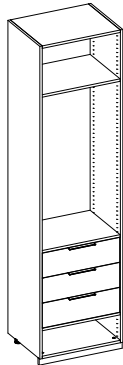

1 tablette fixe
1 bloc 3 tiroirs
1 penderie

D24-M13

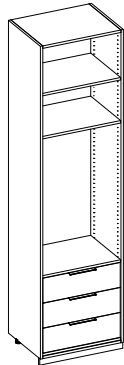

1 tablette fixe
1 tablette semi-mobile
1 bloc 3 tiroirs
1 penderie

D24-M14

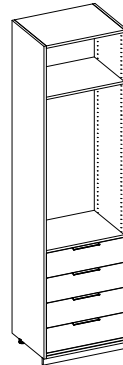

1 tablette fixe
1 bloc 4 tiroirs
1 penderie

D24-M15

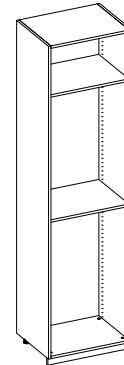

2 tablettes fixes
2 penderies

ELEMENTS DE FINITIONS

Sur-mesure



Joue de finition
19 mm ou 25 mm

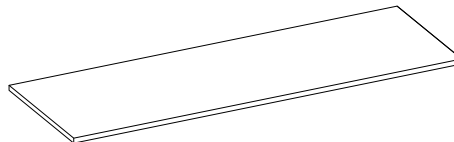

Plateau
19 mm ou 25 mm



Fileur
Bandeau
Plinthe